



GOVERNMENT OF INDIA

FIRE SAFETY

A MONOGRAPH

Operating Plants Safety Division



Atomic Energy Regulatory Board

Niyamak Bhavan

Fire Safety – A Monograph

Revision No.	Published/revised in	Contributors for monograph
0	April, 2008	K. Ramprasad, Ashis Kumar Panda, Diptendu Das
1	May, 2019	Phanikarthik V, Vora Allarakha, Paridhi Aggarwal, Vishwajit Bhatkhande

**Atomic Energy Regulatory Board
Anushaktinagar,
Mumbai – 400 094
India**

May 2019

Contents

1.0	Introduction	1
2.0	Theory of Fire	2
2.1	Basics of Fire	2
2.2	Stages of Fire	5
2.3	Combustion Phenomena	6
3.0	Control of Fire	7
3.1	Fire Prevention	7
3.2	Fire Protection	8
3.3	Difference in Fire Prevention Fire Protection	21
4.0	Techniques of fire safety analysis	22
4.1	Introduction	22
4.2	Fire Hazard Analysis	22
4.3	Fire Probabilistic Safety Analysis	23
5.0	Regulations for Fire Safety	24
6.0	Case Studies and lessons learnt	25
6.1	Fire Incidents occurred in DAE units for last 10 years	25
6.2	Lessons learnt from Fire Incidents occurred in other industries	26
6.3	Fire Incidents in day to day life	30
7.0	Conclusion	30
	Acknowledgement	31

1.0 Introduction

“Fire is a good servant but bad master”, means controlled fire is one of the necessity for living of human beings but uncontrolled fire is dangerous for life and property. Discovery of fire is one of the main aspects which have marked the dawn of civilization. Our ancestors’ ability to master the fire was an important turning point in the cultural aspect of human evolution. Today, fire is an integral part of human civilization and the heart of industrialization. But to gain the most from fire, we need to contain and control it.

Fire incidents pose serious threat to the safety of life, property and environment, irrespective of their location i.e. industry, public places or places of habitation. Consequences of fire in the refineries or chemical plants can be severe, but for the nuclear installations, risk of release of radioactivity makes it more severe. Till date many disastrous fire events have been recorded in industries throughout the world. In India, the incident of fire & explosion at Bombay Dock on 14th April 1944 has become an inalienable part of the history. Annually, this day is observed as **National Fire Service Day** in the memory of 66 firemen who lost their lives while battling the devastating fire. In spite of several advances made in fire detection and firefighting techniques, fire continues to be highly unpredictable and hence the best course of action is to put the maximum emphasis on fire safety aspects viz. prevention, detection & protection.

In pursuance of its objective to ensure safety of members of the public and occupational workers as well as protection of environment, Atomic Energy Regulatory Board (AERB) has been entrusted with the responsibility of laying down safety standards and enforcing rules and regulations in DAE units. AERB has published fire safety specific standard, guidelines and monograph to emphasize requirements of fire prevention and protection measures and enforce their implementation. The main objectives of fire safety are

1. To minimize both the probability and the consequences of postulated fires.
2. To detect and suppress fire with particular emphasis on passive and active fire protection system and adequate capacity for the systems necessary to achieve and maintain safe plant shut down with or without off-site power.
3. To ensure that a failure, rupture or an inadvertent operation does not significantly impair the safety capability of the structures, systems and components.
4. To address not only the direct effects of flame, radiant heat and explosion but also to the potential for the release of hazardous materials and hazardous combustion products in the event of fire and the potential for the release of water and other firefighting media contaminated during firefighting.

A monograph on fire safety was published by AERB in April 2008 with an objective to create awareness about fire safety amongst general public and persons working in industry including safety professionals. With rapid changes in technologies of fire prevention, detection and suppression and complexity of plant designs, the need for revision of the monograph was felt.

The present revised monograph is aimed to introduce aspects such as basics of fire, its complexity and prevention & protection measures to its reader. It covers theory of fire

(aspects about origin of fire, stages of fire and combustion phenomena), control of fire (fire prevention and protection), techniques for fire safety analysis (Fire Hazard Analysis and Probabilistic Analysis), regulations for fire safety and selected case studies of fire accidents with lessons learnt.

The information provided in this Monograph is of generic in nature and not adequate for instituting a fire safety programme for a facility. Details may be obtained from respective standards, relevant books and manuals for this purpose.

2.0 Theory of Fire

2.1 Basics of Fire

Fire is the rapid oxidation of a combustible material (fuel) in the presence of an oxidiser (oxygen, air, etc.) and ignition source, releasing heat, smoke, light, and various reaction gases.

The components of fire can be explained by ‘Fire Tetrahedron’ diagram. Faces of the pyramid represent Heat, Fuel and Oxygen respectively, while base of this pyramid is the combustion Chain Reaction. If any one component is separated from the others, fire can be extinguished. For example - a) if there is an oil fire, foam is used as the extinguishing media for the fire, which covers the oil surface and deprives it of oxygen. b) When water is used as a fire extinguishing medium, the purpose is to remove the heat from the fire.

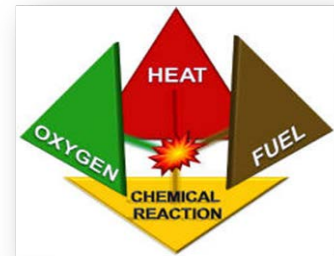

Fire Tetrahedron

The inputs and outputs of a fire (combustion reaction) are depicted in following figure.

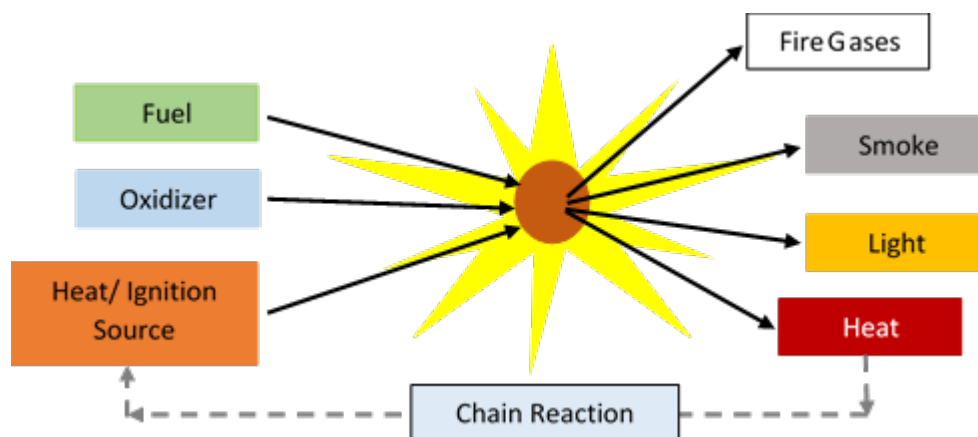

In order to prevent fires from occurring and to extinguish them successfully, an understanding of the chemical and physical characteristics of fire is important.

2.1.1 Inputs of fire

Fuel

Fuel is a material that contains carbon and hydrogen, such as wood, paper and flammable and combustible liquids and gases. Another potential fuel is a combustible metal, such as zirconium or magnesium. Based on fuel, the fires are classified as follows as specified in IS 2190: 2010 on Selection, installation and maintenance of first-aid fire extinguishers - Code of Practice:

Class of Fire	Type of Fuel
Class A	Solid combustible materials of organic nature such as wood, paper, rubber, plastics, etc.
Class B	Flammable liquids like petrol, kerosene, paints, organic solvents etc.
Class C	Flammable gases under pressure including liquefied gases like hydrogen, liquefied petroleum gas (LPG), compressed natural gas (CNG) etc.
Class D	Combustible metals, such as magnesium, sodium, potassium, etc.

Atomic Energy (Factories) Rules, 1996, specifies one more class of fire i.e. Class E for fire involving electrical equipment. When energized electrical equipment is involved in a fire, the non-conductivity of extinguishing media is of utmost importance.

It is important to note that combustion is a gaseous phase phenomenon. Flammable liquids have a low boiling point and produce vapors at ambient temperatures to produce a gaseous phase of fuel above the liquid. Solid fuels first undergo pyrolysis before real combustion can occur. Pyrolysis is the thermal decomposition of combustible materials into simpler compounds that can be ignited. It is the process of converting solid materials into combustible vapors. Because combustion is exothermic, once high temperature is attained, the solid will undergo auto-pyrolysis, making combustion a self-sustaining reaction.

Oxidizer

In terms of oxygen supplies, air is the most common source of oxygen with, on an average, 21% v/v of air is oxygen. However, it should be noted that sources of oxygen can also include oxidizers. Examples of common oxidizers include elements of fluorine, chlorine, hydrogen peroxide, nitric acid, sulfuric acid, and hydrofluoric acid.

Ignition Source

An ignition source is a process or event which can cause a fire or explosion e.g. excessive electrical current, heating equipment, naked flames, sparks and lightning.

The auto-ignition temperature of a substance is the lowest temperature at which it spontaneously ignites in normal atmosphere without an external source of ignition, such as a

flame or spark. Certain materials can be auto-ignited if surrounding temperature increases above their auto-ignition temperature.

Factors such as the rate of heat rise, the duration of heating, size & shape of material and oxygen in the air also influence ignition temperature of material. If oxygen level is richer, lower is the ignition temperature. Size and shape of material also influence ignition temperature. This phenomenon of auto-ignition of material due to fine size particles is called as pyrophorocity. With the exception of the noble metals, all of the common metals oxidize in air if they are in the form of fine particles. Under the proper conditions, they may burn or self-ignite; for example iron, copper, and nickel (0.01-0.03 μm in particle size), tungsten (1 μm), and zirconium and sodium (10 μm) will all spontaneously ignite in air on disturbance or light impact.

Chemical chain reaction

Chemical chain reaction of fire occurs within the material itself when the fuel is broken down by heat, producing chemically reactive free radicals, which then combine with the oxidizer. There are four major products of combustion: heat, smoke, light, and fire gases. These products of combustion are critical not only in terms of extinguishment but also in terms of life safety and building design. The primary loss of life in a fire is due to the toxic fire gases.

2.1.2 Outputs of fire

Heat

Heat from fire affects the body in several ways, but the two major factors that determine its effect on the body include the length of exposure and the temperature. As a rule of thumb, one should not enter areas exceeding 120°F or 49°C without proper personal protective equipment. Exposure to excessive heat causes an increased heart rate, dehydration, exhaustion, burns etc.

Smoke & Fire Gases

Smoke is the result of airborne solids and liquid particulates. Fire gases are mixture of hot air, particles and combustible gases such as carbon monoxide and incombustible gases such as carbon dioxide that result from combustion. Smoke reduces visibility and irritates eyes and lungs, and in many cases, the fire gases in smoke are lethal. In addition to the toxicity of smoke, it is also important to consider the effect of smoke on vision. Smoke obscures the passage of light, thereby possibly blocking the visibility of exits and impeding escape from a fire.

The effects of fire gases on the body is influenced by the concentration of the gases present, the length of exposure time, and the physical condition of the individual exposed. During a fire, carbon monoxide is produced and has toxicity based on carbon monoxides' affinity for carboxy-hemoglobin in the blood and may be fatal in less than an hour if concentration is high. While carbon dioxide is low in toxicity and is not normally considered a significant toxin in smoke. However, carbon monoxide increases the speed and depth of breathing, thereby increasing carboxy-hemoglobin in the blood. Combustion of materials containing nitrogen bonds, such as wool and silk, result in the release of hydrogen cyanide (HCN). The

toxicity of HCN is based on the fact that it inhibits cells from using oxygen. Levels of HCN of 135 ppm are lethal within thirty minutes. It should also be noted that during combustion, oxygen is consumed; therefore, oxygen- deficient atmosphere is hazardous when level below 17 percent causing diminished muscular control.

2.2 Stages of Fire

International Fire Service Training Association (IFSTA) explains that there are four stages of a fire, namely ignition, growth, fully developed, and decay.

Ignition - The first stage begins when heat, oxygen and a fuel source combine and have a chemical reaction resulting in fire. This is also known as “incipient” and is usually represented by a very small fire. Identifying a fire in this stage provides best chance of suppression or escape.

Growth - The growth stage is where the structures fire load contributes to the fire. In this stage, fire is limited to origin of ignition material. There are numerous factors affecting the growth stage including where the fire started, what combustibles are near it and ceiling height. It is during this shortest of the 4 stages when a “flashover” can occur; potentially trapping, injuring or killing persons.

Fully Developed - When the growth stage has reached its maximum and all combustible materials have been ignited, a fire is considered fully developed. This is the hottest and most dangerous phase of a fire.

Decay - Usually the longest stage of a fire, the decay stage is characterized by a significant decrease in oxygen or fuel, putting an end to the fire. Two common dangers i.e. the existence of non-flaming combustibles, which can potentially start a new fire if not fully extinguished and danger of a backdraft when oxygen is reintroduced, exist during this stage.

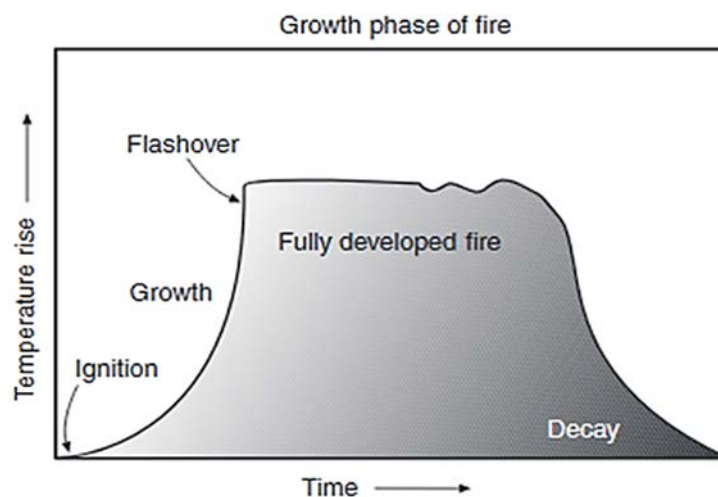

2.3 Combustion Phenomena

Basics of fire and stages of fire are covered in earlier sections. In case of fire incident, fire may progress and result in to any of the following unique combustion phenomena namely, explosions, deflagrations, detonations, flashovers, and back drafts.

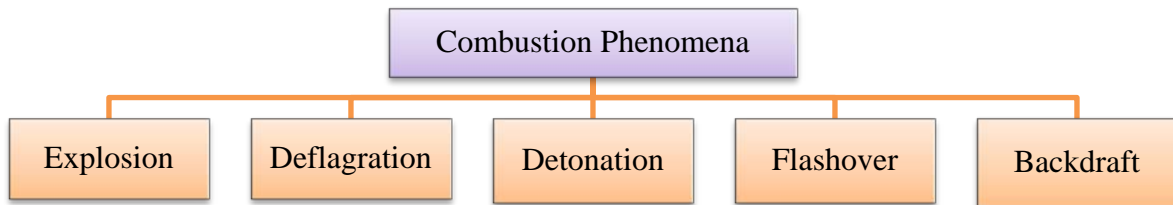

Explosion

An explosion is the rapid release of high-pressure gas into the environment. The main difference between a fire and an explosion is the rate at which energy is released. Sources of explosions in industry are most commonly associated with combustion explosions that involve fuels.

Deflagration

A deflagration is the burning of a gas or aerosol that is characterized by a combustion wave. The combustion wave moves through the gas and oxygen, burning until all the fuel is used. With a deflagration, the rate of travel of the combustion wave is less than the speed of sound.

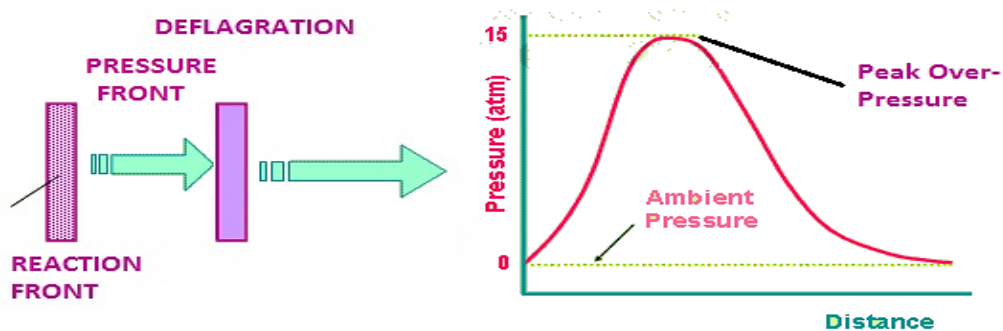

Detonation

A detonation, another unique combustion phenomenon, is the burning of a gas or aerosol characterized by a shock wave. With detonation, the shock wave travels at a speed greater than the speed of sound, and the wave is characterized by very high pressure initiated by a

very rapid release of energy. The very high pressure created from the shock wave also serves to create a heat source for igniting other combustibles.

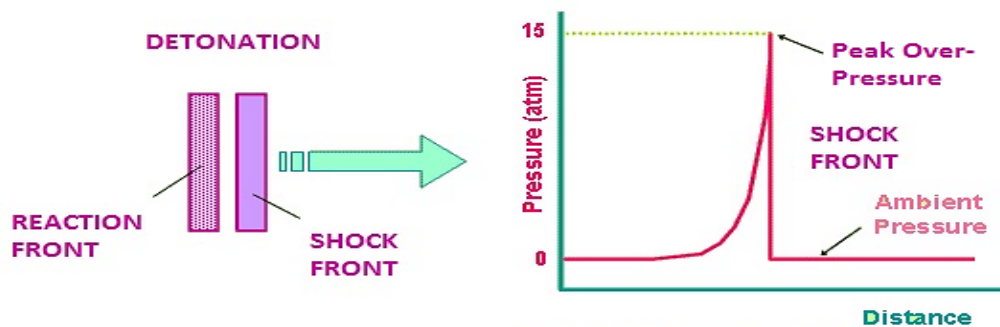

Flashover

A flashover is a fire in an enclosed area that fosters the buildup of heat; when the temperature reaches the ignition temperature of the majority of combustibles in the area, there is spontaneous combustion of the combustibles in the area.

Backdraft

A back draft is sometimes referred to as a smoke explosion because it is a fire in an enclosed area that consumes the oxygen supply and generates carbon monoxide and heat. As the oxygen is being used up, the fire tends to smoke a lot; then, if outside air is introduced, the carbon monoxide will burn rapidly with explosive force.

References:

1. Fire Services in India History Detection Protection Management Environment Training and Loss Prevention - S. P. Bag (1995)
2. "Fire Hazard Analysis Techniques" - Hurley, Morgan J. and Richard W. Bukowski (2008)

3.0 Control of Fire

3.1 Fire Prevention

Fire prevention is the elimination of the possibility of a fire being started. However, as the risk cannot be completely eliminated, it is advisable to adapt/ implement optimum fire prevention measures at the design stage itself. This design stage is not limited for industry only, rather it is also applicable to cases like modification or construction of a new structure be it a residential or commercial. Prevention can occur through successful action on the heat source, the fuel source or the behavior that brings them together. Such actions involve regular housekeeping, safe and appropriate disposal of waste, safe storage of combustibles e.g. LPG cylinders, wooden waste etc.

In case of industries, fire prevention activities can be categorized into engineering and administrative functions. Engineering functions of fire prevention refers to the careful

planning of the fire safe buildings (designed to minimized risk of fire) & processes. It also covers proper building design & construction by fire retardant materials, segregation of fire hazard processes by proper layout, identification of process hazards w.r.t fire, analysis of their consequences and installation of suitable fire prevention systems in the plant. Administrative functions of fire prevention involve deployment of manpower competent in fire safety (fire station), preparation & implementation of procedures, surveillance requirements for engineering systems involved in fire safety, training on firefighting, enforcement etc.

Engineering and administrative functions of fire prevention complement each other and their effective coordination will help in reducing the risk of fire hazard.

Elaborate engineering and administrative measures of fire prevention may not be required for a residential structure or commercial establishment apart from industry; however, compliance to the requirements specified by National Building Code and other statutes, should be implemented to reduce fire hazard in day to day life.

3.2 Fire Protection

Following topics will brief about two important aspects of fire protection namely, detection and suppression/ mitigation.

3.2.1 Fire detection and alarm system

As mentioned in above chapter, a fire generally develops in four stages namely – ignition, growth, fully developed and decay. Detection of fire at an early stage (ignition stage) can prevent further development of fire as necessary automatic/ manual fire extinguishing action can be initiated without delay.

A Fire Detection and Alarm System (FDAS) provides audible and visual signals as a result of the operation of manual or automatic fire alarm initiating devices such as a Manual Fire Alarm station, smoke detector or heat detector. Manual Fire Alarm Stations (Pull Boxes), Smoke detectors, heat detectors etc. are initiating devices for FDAS. Audible devices, like horns, bells, buzzers and chimes and visual signal devices like strobes and signs are all notification appliances used in FDAS. A control panel connects the initiating devices and the notification appliances together to form a system.

The basic fire detection and alarm system consists of the following:

1. Control Panel, the center of the system that controls the functions of the system.
2. Initiating Devices, the devices that provide the input to the control panel when they are activated.
3. Notification Appliances, the devices that notify the occupants of a building of the fire condition.
4. Primary and Secondary Power Supplies

In conventional FDAS system, initiating devices installed in the building zones are connected to circuits in the control panel. Using this method of zoning, the areas of the building and the

devices of the conventional system can provide information to the responding personnel as to the location of the fire and the type of device that initiated the alarm.

Analog/Addressable FDAS uses a two way communication method to communicate with the control panel and can provide much more information than conventional devices (normal/alarm state). The detectors/ initiating devices are wired in a loop around the area with each detector having its own unique 'address'. The fire control panel 'communicates' with each detector individually and receives a status report e.g. healthy, in alarm or in fault etc.

The fire detectors, in addition to annunciation and activation of fire suppression system, can perform a number of functions such as actuation of fire doors, smoke dampers, and shut down of power-operated equipment, if connected with those systems.

3.2.1.1 Types of fire detectors

Fire detectors are mainly classified based on principle of fire detection (smoke/flame/heat) and area of coverage (spot / line type).

a) Smoke Detectors: These detectors detect fire, based on the products of combustion. Smoke detectors are further classified into:

i) Ionization Detector - This type of detector consists of one or more chambers, provided with a very small amount of radioactive element (Americium-241) which emits radiations to ionize the air inside the chamber. In normal state, the two charged electrodes inside the chamber conduct electric current due to ionization of air. The detector operates when smoke enters into the chamber and reduces the conductivity of the air inside, below a pre-defined level, which in turn reduces the current between the electrodes. Working principle of Ionization detector is depicted below:

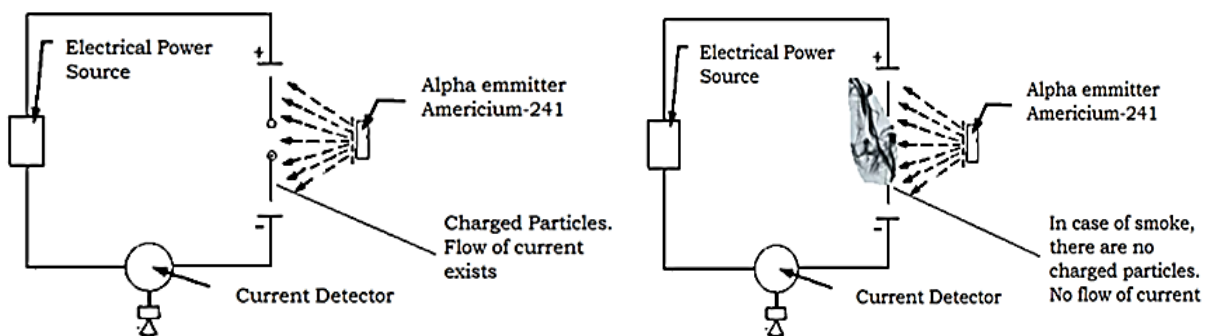

Working Principle of Ionization Detector

ii) Photoelectric Detector – This type of detector employs the light scattering principle of smoke for detection. A light source (pulsed Infra-Red LED) and a light sensor (photo resistor) are arranged in a chamber in such a way that major portion of the light does not fall on the sensor. When smoke particles enter the light path inside the chamber, the light is scattered and this scattered light falls on the sensor which converts it into a signal for further action.

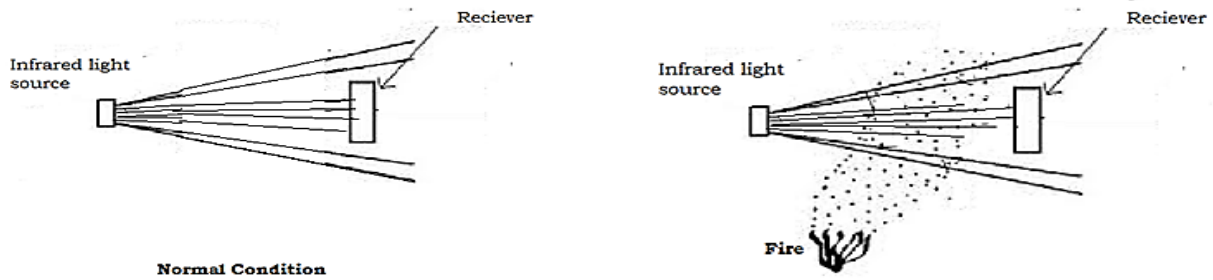

Working Principle of Photoelectric Detector

iii) Aspirating Detector – This detector consists of a central detection unit which draws air through a network of pipes to detect smoke. The sampling chamber is based on a nephelometer (an instrument for measuring the size and concentration of particles suspended in a liquid or gas, especially by means of the light they scatter) that detects the presence of smoke particles suspended in air by detecting the light scattered by them in the chamber. These detectors can typically detect smoke before it is visible to the naked eye. Aspirating smoke detection actively draws air in through sampling pipes using powerful fan and therefore does not rely on smoke naturally passing through a detector.

iv) Beam type Detector – This type of detector operates on the principle of obstruction of light. A light transmitter transmits a pulsed beam of IR light, which is received by the receiver. When the received beam intensity goes below the preset level due to smoke particles, the detector issues a signal for further action.

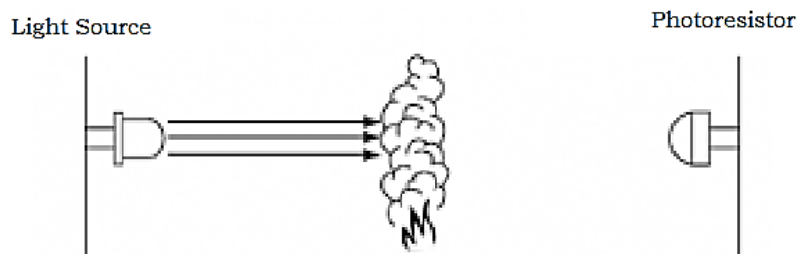

Working Principle of Beam type Detector

b) Flame Detectors

This type of detector works on the detection of radiant energy of the flame at different wavelengths. Basic types are Infra-Red (IR) & Ultra Violet (UV) type. IR radiation is produced in all flames during burning of carbonaceous materials such as alcohol, mineral insulated oil, petrol, diesel etc. UV radiation is emitted where hydrogen and certain materials involving sulfur are burnt. IR type flame detectors have an infrared cell as sensor and UV type flame detectors have a vacuum photo diode Geiger-Mueller tube as a sensor.

c) Heat Detectors

i) Fixed Temperature Detector - This type of detector initiates a signal when the air surrounding it goes above a preset temperature. The sensor is usually a bi-metallic strip that closes a contact or a thermistor (whose resistance decreases with temperature) along with associated circuitry.

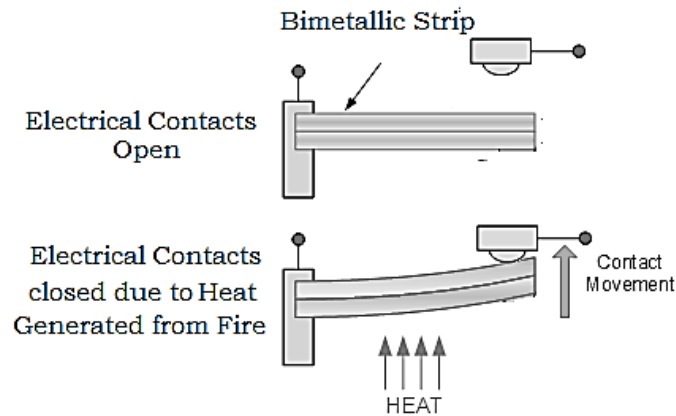

Working Principle of Bimetallic strip type Detector

ii) Rate of Rise Temperature Detector - This type of detector operates when the rate of rise of temperature of the air surrounding the detector exceeds the preset rate of rise. This is normally an electronic type of detector, which has two sensing elements (thermistors). One element is exposed to the surrounding while the other is insulated from the surrounding. Both sensor data are compared and checked with preset rate of rise for signal actuation.

iii) Linear Heat Sensing (LHS) Cables – These are unique heat sensing cables made of polymer insulating material having a negative temperature coefficient of electrical resistance. These cables and associated systems can detect heat anywhere along the length of the cable. They are of two types - a) analog and b) digital. Temperature change anywhere along the zoned length of the sensor cable produces a corresponding change in the resistance of the insulating material used in the cable. In analog type LHS cables, this data is used by the associated system for generation of alarm. In digital LHS cables, the temperature change causes an insulation break down (short-circuit) which is used by the associated system for generation of alarm. Analog LHS cables are self-restoring type if not subjected to a temperature of more than 250°C. Digital LHS cables are not self-restoring type and damaged portions of the cable need to be replaced by new one.



iv) Quartzoid Bulb - This is the most common type of heat-sensing device used in water sprinkler systems. This is basically a quartz bulb that contains a special volatile liquid. The volumetric expansion of the liquid breaks the bulb when its temperature increases beyond a



certain temperature. This phenomenon is used for further generation of fire alarm/actuation of fire suppression system.

3.2.1.2 Selection of fire detectors:

Detectors are selected based on the nature of products released during fire, carbonization, or the initial bursting into flame of the materials present in the fire hazard area. The selection may be confirmed based on Fire Hazard Analysis (FHA) or any other suitable hazard analysis technique. In selection of detection and alarm system, it is also important to consider the reliability of the system and individual components to always perform their intended functions. For fire detection systems, this reliability may be affected by the reduction in sensitivity or of sensing devices leading to non-detection or late detection of a fire, or the spurious operation of an alarm system when no smoke or fire hazard exists. Generally detectors are connected with audible and visual annunciation system. It should be ensured that alarms are distinctive and audible to all areas of workplace.

Selection of fire-detection equipment should also consider the environment in which it functions, e.g. radiation fields, humidity, temperature and air flow. In cases where the environment (e.g. higher radiation level, high temperature etc.) affects functioning of detectors, alternative methods, such as sampling of the gaseous atmosphere from the affected area for analysis by remote detectors with an automatic operation may be considered. If spurious operation of detector is detrimental to the plant, activation can be governed by two lines of protection system. Provision for manually activated fire alarms can also be made e.g. manual call point.

Important points for consideration:

- ✓ Fire detectors should be installed at strategic locations identified based on analysis.
- ✓ Fire detection and alarm system should be supplied with reliable & uninterrupted power supply, so that at all times the system will be active.
- ✓ Fire detection and alarm system should be periodically maintained and calibrated to ensure their healthiness and availability at all time.

Following table compares types for detectors for their advantages, disadvantages and application:

Type of Detector	Advantages	Disadvantages	Application
Smoke-Ionisation	Early warning. Incipient fires. Low unit cost.	Response may be adversely affected by environmental dust, humidity greater than 95%, temperature (> 60 deg. C) etc. Affected by high	Indoors, homes, offices, computer rooms. Class A, B and C fires.

		radioactive environment.	
Smoke-Optical (Photo-electric & Beam)	Early warning of smoldering fire. Low unit cost.	Smoke must be contained. Limited to indoor use. Response may be adversely affected by environment.	Indoors, homes, offices, commercial buildings. Class A fires.
Heat detector	Reliable and simple. Effective indoor. Low unit cost.	Slow. Affected by wind.	Indoors. Enclosed areas. Class B and C fires
Flame - Infrared (IR)	Fast response. High sensitivity. Manual self-test through the window.	No automatic self-test. High unit cost.	Indoors, air ducts. Class B and C fires.
Flame - Ultraviolet (UV)	Highest speed. Highest sensitivity.	Subject to false alarms from other sources in the vicinity. High unit cost. Blinded by thick smoke.	Outdoors/indoors. Class D fires.
Flame - Dual Detector (IR and UV)	High speed. High sensitivity. Low false alarm rate. Wide temperature range. Automatic self-test.	Thick smoke reduces range. High unit cost.	Outdoors/indoors. Class A, B, C and D fires.

3.2.2 Fire Suppression/ mitigation

Since the risk of fire cannot be completely eliminated, availability of fire suppression/mitigation systems is necessary. Fire can be extinguished by implementing one of the following four principles:

- a. Cooling: Reduce the heat.
- b. Smothering: Cut off the oxygen supply to the fire.
- c. Starvation: Isolate the supply of fuel to the fire.
- d. Inhibition: Stop the chemical reaction of fire.

Basically fire is classified into four types, based on the type of fuel. Extinguishing medium is selected based on this classification. The classification of fire and respective suitable fire extinguishing mediums are as follows:

Class of Fire	Fuel Source	Extinguishing Medium
A	Fire involving combustible material such as wood, paper, cloth, rubber, plastic etc.	Water, aqueous film-forming foam, multipurpose dry chemical powder (DCP)
B	Fire involving flammable or combustible liquids, greases, petroleum products and similar materials	Aqueous film-forming foam, CO ₂
C	Fire involving flammable gases, substances under pressure including liquefied gases	CO ₂ , multipurpose dry chemical powder (DCP)
D	Fire involving combustible metals such as sodium, magnesium, zinc, potassium etc.	Special dry chemical powder such as Ternary Eutectic Chloride (TEC) / Bi-carbonate based powders

Fire suppression systems include active systems such as fire pumps, fire hydrants, sprinklers, extinguishers which will help in extinguishing the fire while passive systems such as fire barriers, fire seals, fire retardant paints etc. which will help in restricting the propagation of fire. Active fire protection systems can be either fixed type or portable type, which include - water system, foam system, gaseous system & portable fire extinguishers.

3.2.2.1 Active Fire Protection Systems

Active fire protection system is a fire protection system or feature such as automatic sprinkler, fire detector, smoke removal system which operates or activates automatically or manually.

I. Water system

In these systems water is used as the fire extinguishing medium. E.g. fire hydrant system and sprinkler and other water spray systems.

a) Fire hydrant or standpipe and hose system

It consists of a pipe carrying water from storage source to all areas of facility. This pipe is laid in a ring manner, such that every hydrant point can be fed with two different directions, thereby keeping redundancy of water supply. Every hydrant point is installed at conspicuous places as per the requirement and provided with suitable hoses & nozzles. Water is supplied through fire pumps either electrically driven or diesel engine driven. Being an integral part of fire safety system, redundancy and diversity in fire pumps is provided to ensure availability during emergency condition.

Most multistory buildings or structures be an industry or residential, have either wet riser or dry riser. Riser is a vertical pipe exclusively provided to distribute water to multiple levels of a building or structure for firefighting. Wet riser or wet standpipe are kept full of water for

manual or automatic firefighting operations while dry riser is a normally empty pipe that can be externally connected to a pressurized water source by firefighters. Dry risers are used in cold regions where water could freeze. The fire hydrant system should conform to relevant standards such as IS 908:1975 (Specifications for Fire Hydrant and Stand Post Type), IS 3844:1989 (Code of Practice for Installation and Maintenance of Internal Fire Hydrants and Hose Reels on Premises), etc.

b) Fire sprinkler system

A fire sprinkler system consists of a water supply system, providing adequate pressure and flow rate to a water distribution piping system, onto which fire sprinklers are connected. Sprinkler systems can be classified according to their design and operation. The most common type sprinkler systems are wet-pipe systems, dry pipe systems, pre-action systems and deluge system. The selection of type is based on the type of environment in which it will be used, e.g. wet pipe sprinkler systems are the most versatile system found in a variety of occupancies, including businesses, residential and industrial occupancies.

In wet pipe system water is present throughout the piping i.e. from riser to sprinkler head. As sprinkler heads open, water is discharged immediately. Dry pipe systems are used in areas of building that are susceptible to freezing. In dry pipe system, water is only present in the system upto the check valve at the riser.

Pre-action fire sprinkler systems employ the basic concept of a dry pipe fire sprinkler system in that water is not normally contained within the pipes. But rather holding water from piping via pressurized air or nitrogen, pre-action sprinkler systems restrain water with an electrically operated valve, known as a pre-action valve. Sprinklers of a pre-action system get opened when sensors in the area of the fire are activated which in turn open the pre-action valve to the sprinkler system allowing water to flow through to the affected area.

In a deluge system, all sprinkler heads in the system are open at all times. It is similar to a pre-action system except the sprinkler heads are open and the pipe is not pressurized with air. Deluge systems are connected to a water supply through a deluge valve that is opened by the operation of a smoke or heat detection system. When the deluge system is activated, water flows through the piping and is discharged through all sprinkler heads.

c) Water mist system

A water mist system is a fire protection system which uses very fine water sprays (i.e. water mist). As a result of water being atomized into such fine droplets at high pressure, the surface area available for cooling is considerably greater than that of conventional low-pressure sprinkler system. The strong cooling effects serve not only to fight fire but protecting lives and property against effects of radiated heat. The small water droplets allow the water mist to control, suppress or extinguish fires by:

- cooling both the flame and surrounding gases by evaporation
- displacing oxygen by evaporation
- attenuating radiant heat by the small droplets themselves

The effectiveness of a water mist system in fire suppression depends on its spray characteristics, which include the droplet size distribution, flux density and spray dynamics, with respect to the fire scenario, such as the shielding of the fuel (of fire), fire size and ventilation conditions. Water mist systems are most advanced system and has following substantial advantages over conventional water spray system and gaseous systems:

- a) Immediate activation
- b) High efficiency in the suppression of a wide variety of fires
- c) Minimized water damage
- d) Environmentally sound characteristics
- e) No toxic problems

Water mist system is provided for Hydrogen sulphide storage tanks in industries to protect the tanks in case of fire.

II. Foam System

Foam type fire extinguishers are used in case of fire in flammable/ combustible liquids and are installed to protect areas where large quantity of flammable liquid is stored. Firefighting foam is an aggregate of gas-filled bubbles from a water-based solution. The gas used in the bubbles is typically an inert gas. Since foam is lighter than liquids, it will float on the flammable and combustible liquids producing a layer that cuts oxygen, cools and produces a vapour seal. Foam systems are automatic, totally self-contained and require no manual intervention for operation.

Foams are defined by their expansion ratio of the volume of foam after air is added to the volume of the foam before air is added. Foam systems are classified into three categories namely – low expansion, medium expansion and high expansion. Foam system application can be in the form of sub surface injection, surface application, seal protection for floating tank roofs or dyke protection. Low expansion fixed foam system with sub surface injection; surface application or seal protection is normally used to protect large storage tanks of flammable liquids. Low expansion fixed foam system for dyke protection is used for protection of tank farm area with dyke which stores a number of vertical as well as horizontal flammable liquid storage tanks. Low expansion foam system is suitable for oil pool fires where a thin layer of foam on the oil surface can quench the fire by depriving it of oxygen (smothering effect). High expansion foam systems operate on the principle of mechanical expansion of the foam by air and water. These systems are suitable for fighting three dimensional fires such as a fire in LNG pump where total flooding up to the elevation of the object under fire is necessary which quenches the fire by smothering, cooling, insulation & penetration.

III. Gaseous system

Fire suppression system that uses gas as the extinguishing medium is of two types - Carbon dioxide & halon, both in built-in systems and portable fire extinguishers.

a) Carbon dioxide (CO₂) system

CO₂ is a noncombustible, nonreactive gas that has been used as an extinguishing medium. It extinguishes fires primarily by displacing the oxygen surrounding the surface of the burning material. While carbon dioxide is normally used to suppress fires of electrical systems, it also works as extinguishing medium for most materials except cellulose materials. As cellulose materials themselves are source of oxygen due to their composition, it is difficult to use CO₂ as extinguishing medium for them.

Since CO₂ gas concentration greater than 5% v/v is a hazard (asphyxiation) to working personnel, due care should be taken in designing the system. This system should only be used in areas where required CO₂ concentration can be maintained to extinguish fire. In automatic carbon dioxide systems, there should be pre-discharge alarm & discharge delay to permit personnel evacuation.

b) Halons

Halogenated materials (halons) use a hydrocarbon material with an atom of the halogens such as fluorine, bromine, chlorine or iodine. By adding this halogen atom, the gas becomes non-flammable. Previously halons were extensively used as fire extinguishing medium, however, halons pose a threat to the environment by depleting ozone layer due to presence of chlorine and bromine. Because of detrimental effects on environment, halons are not being used and being phased out from old systems. Nowadays, other chemicals with trade names FM200, HFC-23 are being used as fire extinguishing medium in place of halons, as they are safe and have zero ozone depleting potential (ODP).

IV. Aerosol based suppression system:

Aerosol based suppression system is composed of micro-sized particles(generally potassium compounds). When the Aerosol based suppression system is activated, thermally or electrically, the solid micro particles and a gas mixture (mainly CO₂ , N₂ and water vapour) are mixed to form an extinguishing mixture. The principle of extinguishment of fire is that solid particle ionizes be the energy present in fire, thereby reducing the temperature of the fire. The solid particles also react with the instable molecule fragments (responsible for chain reaction of fire) and form stable product, there by interrupting the chain reaction and flame is extinguished.

V. Portable Fire Extinguisher

Portable fire extinguisher is commonly used to extinguish or control small fires. It is not intended for use on an out-of-control fire, endangers user. Typically a fire extinguisher consists of a hand-held cylindrical pressure vessel containing an extinguishing agent.

There are two main types of portable fire extinguishers: stored type and cartridge-operated. In stored pressure units, the expellant is stored in the same chamber as the firefighting agent

itself. Depending on the agent used, different propellants are used. With dry chemical extinguishers, nitrogen is typically used; water and foam extinguishers typically use air. Stored pressure fire extinguishers are the most common type. Cartridge-operated extinguishers contain the expellant gas in a separate cartridge that is punctured prior to discharge, exposing the propellant to the extinguishing agent.

Fire extinguishers are further divided into hand-held and trolley mounted. Portable as well as trolley mounted fire extinguishers for different class of fire should be kept at various locations. Portable fire extinguishers are available with all extinguishing media. It is worthwhile to note that where energized electrical equipment is involved in fire, the non-conductivity of the extinguishing media is of utmost importance and only CO₂ and DCP should be used. Once the electrical equipment is de-energized, extinguishers suitable for Class- A, B or C may be used safely. The extinguishers should be kept as near as possible to the fire exits and stair case landing in addition to the places where there could be a fire hazard to safety related equipment.

VI. Fire Tender

Fire tender is a vehicle used exclusively for firefighting purpose. It is fitted with portable firefighting equipment. It is equipped with water tank, pump, hose reels, portable fire extinguishers, ladder, cable winch, emergency lighting system etc. Though primary function of a fire tender is firefighting, now a days it is also used for rescue operation for persons trapped in a confinement which may or may not be affected by fire. Rescue tools such as hammers, shovels, portable electric tools, etc. are fitted on modern fire tenders.

Fire tenders are driven/ operated by authorized persons of fire brigade/ fire station. Normally a crew consisting of sub officer, leading fireman/ firemen and a driver accompany the fire tender during firefighting/ rescue operation.

VII. Fire Station

Fire station houses firefighting equipment like fire tenders, fire hoses, personnel protective equipment, portable fire extinguishers etc. It provides working space for firefighters and other supporting staff. Generally it also includes a fire control room from where communication during fire emergency is facilitated and drill tower. A factory may have its own fire station and fire brigade or may take help from fire station of other factory or nearby town/ city.

VIII. Fire Brigade

Fire brigade consists of qualified & trained staff and may include chief or deputy chief fire officer, station officer, sub officer, leading firemen, firemen and other supporting staff. They carry out regular inspection and maintenance of equipment, training w.r.t fire safety in addition to firefighting and rescue operations in actual emergency situations such as oil spillage, toxic releases etc. Periodic exercises are also conducted to check response of fire squad.

In DAE units fire stations are classified into three categories, based on fire hazard potential, area of coverage besides functional requirement like operation of fire station and training/ fire drills. Based on this classification, availability of minimum staff requirement at a particular

fire station and equipment is specified in the AERB Safety Standard on Fire Protection Systems for Nuclear Facilities (AERB/NF/SS/FPS (Rev. 1)).

3.2.2.2 Passive Fire Protection Systems

Passive fire protection systems are an integral component of fire protection systems. They are built in fire protection features such as fire rated construction that provide fire safety and do not require activation. They attempt to contain fires in affected area or slow down its spread from one area to another. Passive fire protection systems are known as building materials that are always present and available within the building, placed and located evenly at every floors of the building. These materials do not rely on the operation of any mechanical device in order to be activated or triggered like active systems. Application of these passive systems is aimed to:

- ✓ Contain the growth and spread of the fire within the building or its compartment where it got ignited
- ✓ Reduce the amount of damage to the building inflicted by the fire and protect the safety systems, if any
- ✓ Reduce the possible life and health risks to the occupants of the building

These systems include fire walls, fire doors, fire-resistant glasses, fire resistant rated floors, fire dampers, fire stops, electric cable coating, fire proof cladding and occupancy separation. These systems are classified based on their fire resistance rating i.e. their ability to contain the fire for a certain time. Fire resistance rating is defined as the time that a material or construction will withstand the standard fire exposure as determined by fire test done in accordance with standard methods of fire tests of materials/ structures. Some of the passive fire protection systems are described below:

- Fire Barrier – It is a structure, partially or completely limiting the spread and consequences of fire. These are installed as per the rating calculated in fire hazard analysis. Floors, walls and ceilings having adequate fire rating and separating fire areas may be called as fire barriers. Any opening through such barrier should be sealed or closed to provide fire resistance rating of at least equal to that of the barrier itself. Opening for ventilation duct should be protected by a fire damper of at least equal rating.
- Fire Damper – It is a type closure which consists of a normally held open damper installed in an air distribution system or in a wall or floor assembly and designed to close automatically in the event of a fire in order to maintain the integrity of fire separation. They are used in heating, ventilation and air conditioning (HVAC) ducts to prevent spread of fire inside the ductwork.



Fire Damper

- Fire Door – It is a door with fire resistance rating which is used to reduce spread of fire and smoke between separate compartments of a structure and to enable safe egress from a building or structure. These doors are made of a combination of materials such as glass section, gypsum (as an endothermic fill), steel, timber, vermiculite-boards aluminium and GI. Specific ratings in terms of hours are assigned to fire doors (e.g. fire door of 3 hr. rating), which are used based on hazard assessment.
- Fire stop is a fire resistant material or construction having a fire resistance rating of not less than separating elements installed in concealed spaces or between structural elements of a building to prevent the spread or propagation of fire and smoke through walls, ceilings. It is used to seal around openings and between joints in the wall or floor. They are designed to maintain the fireproofing of a wall or floor assembly allowing it to impede the spread of fire or smoke.

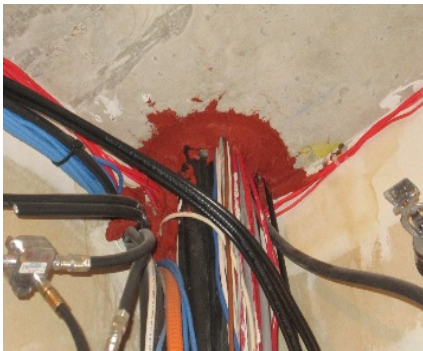

Fire Stop



Fire Door

3.2.2.3 Surveillance & maintenance of fire detection and protection systems

In order to ensure that all fire protection related systems and components function properly and meet design requirements, a formal inspection, testing and maintenance programme and written procedures should be established and documented. Plant administrative procedures should appoint an officer to be responsible for overall coordination of equipment testing and maintenance. The frequency schedule of Fire Equipment Inspection, Testing and Maintenance is given in AERB Safety Standard on Fire Protection Systems for Nuclear Facilities (AERB/NF/SS/FPS (Rev. 1)).

3.2.2.4 Personnel Support System

In addition to fire prevention and protection measures described above, availability of personnel support systems such as emergency breathing apparatus, communication facilities and emergency lighting facilities etc. is essential. Redundancy and diversity should be considered during installation of these support systems.

I. Emergency breathing apparatus

Adequate number of breathing apparatus are provided to the personnel to carry out fire-fighting and rescue operations.

II. Communication

Any reliable mode of communication like phone, PA system, walkie-talkie sets etc. helps in fire emergency to communicate various aspects about fire such as its location, severity, occupancy of personnel and any other important information required. It provides communication link between persons at affected site and other agencies involved in fire-fighting and rescue operations. It also helps the controlling authorities to guide site personnel.

Reference:

1. Fundamentals of Fire Protection for the Safety Professionals: Lon H. Ferguson and Christopher A. Janicak, Government Institutes, The Scarecrow Press Inc., Maryland, USA
2. AERB Safety Standard on Fire Protection Systems for Nuclear Facilities (AERB/NF/SS/FPS (Rev. 1))

3.3 Difference in Fire Prevention and Fire Protection

It is important to consider distinction between fire prevention and fire protection. Fire prevention is the elimination of possibility of a fire being started while fire protection is the strategy to minimize extent of fire by early detection, suppression and mitigation. Following table lists differences between fire prevention and fire protection.

Fire Prevention	Fire Protection
It deals with the causes of fire.	It deals with the system to minimize extent of fire.
It involves identification of probable fire hazards at the design stage.	It involves fire hazard analysis of existing systems also.
Fire prevention is achieved by proper building design & its construction in compliance with statutory requirements.	Fire protection is achieved by designing and installing of fire detection and mitigation system.
It requires preparation of procedures & surveillance requirements for engineering systems involved in fire safety and their implementation.	Fire protection requires procedures to handle fire emergencies.

4.0 Techniques for Fire Safety Analysis

4.1 Introduction

Fire is one of the Common Cause Failure (CCF) initiators. It can have severe consequences with potential to affect personnel, equipment and nuclear/ radiation safety in case of nuclear/ radiation facilities. Therefore, the potential impact of fire needs to be estimated. Available methods to estimate the potential impact of fire can be divided into two categories namely risk-based and hazard-based.

Risk-based methods analyze the likelihood of scenarios occurring, whereas hazard-based methods do not. The fire risk can be quantified for the process industries based on the indices like Dow index (Fire & Explosion Index) and Mond index. These indices are comprehensive and give a realistic value to the risk of individual process unit due to potential fires and explosion. The indices are comprehensive and give a realistic value to the risk of individual process unit due to potential fires and explosion. Facilities handling and storing flammable liquids are exposed to a potential fire risk.

Fire hazard analysis is a systematic study of (a) all elements of the fire protection programme being proposed to ensure that the plant design has included adequate identification and analysis of potential fire hazards (b) the effect of postulated fires relative to maintaining the ability to perform safe shutdown functions and minimizing toxic and radioactive releases to the environment and (c) suggest remedial measures.

This section describes the techniques used for fire safety analysis for industrial establishments.

4.2 Fire Hazard Analysis

Fire Hazard Analysis (FHA) aims to determine the adequacy of the fire protection measures protecting the safety systems and equipment, which are required under all operational states of the plant. Thus FHA ensures mainly three aspects i.e. the fire does not incapacitate the safety systems, the compartment has been provided with adequate barrier rating and the damage due to fire spread is minimized.

A detailed FHA is performed during three occasions at least, a) early in the design phase, prior to initial commissioning for verification of initial analysis, whenever significant change is made, e.g. when there is any addition to combustible material inventories; b) prior to and immediately following major plant (building) modifications; c) major modifications to fire protection systems including fire barriers, fixed suppression systems, fire detection systems etc.

The fire hazard analysis should separately identify hazards and provide appropriate protection in locations where safety related losses could occur as a result of: a) Concentrations of combustible materials, including transient fire loads due to combustibles expected to be used in normal operations; b) Configuration of combustible contents, furnishings, building materials, or combinations thereof conducive to fire spread; c) Exposure to fire, heat, smoke, steam that may necessitate evacuation from areas that are required to be attended for safety

functions; d) Fire in control rooms or other locations having critical safety related functions; e) Lack of adequate access or of smoke removal facilities that impede fire extinguishment in safety related areas; f) Lack of explosion prevention measures; g) Loss of electric power and h) Inadvertent operation of fire suppression systems. The possibility of a fire spreading from one unit to the other unit should be taken into account in the fire hazard analysis. Through FHA the concerns that are addressed include :

- a) Are the combustibles minimized?
- b) Are the risks separated?
 - By Layout
 - By distance, spatial segregation
 - By enclosure
 - By appropriate fire barriers
 - Spill protection (Curbs, Collection Trays)
 - Fire barriers
- c) Do high fire load areas include systems important to safety?
- d) Are detectors and sprinklers appropriately located?

The U.S. Nuclear Regulatory Commission (NRC) has developed quantitative methods, known as “Fire Dynamics Tools” (FDT), to assist in performing fire hazard analysis (FHA). These are published as NUREG 1805.

The analysis of consequences of the postulated fire on safety of the plant should be conducted by the persons trained and experienced in the principles of industrial fire prevention & control.

Further details w.r.t. methodology to perform FHA can be referred to Appendix - A of AERB Safety Standard No. AERB/NF/SS/FPS (Rev.1), Fire Protection Systems for Nuclear Facilities and IAEA Safety Reports Series No. 8, Preparation of Fire Hazard Analyses for Nuclear Power Plants.

4.3 Fire Probabilistic Safety Analysis

Deterministic and probabilistic techniques are used to assess a fire hazard. The deterministic fire hazard analysis, typically carried out first, is normally required by licensing authorities and other safety assessors. It is usually developed early in the design of new plants, updated before commissioning, and then periodically or when relevant operational or plant modifications are proposed. Probabilistic safety assessment (PSA) for fire is undertaken globally to supplement the deterministic fire hazard analysis. It should be noted that a fire PSA is recognized as a tool that can provide valuable insights into plant design and operation, including identification of the dominant risk contributors, comparison of the options for risk reduction and consideration of the cost versus risk benefit.

Fire PSA is the analysis of fire events and their potential impact on the safety of a plant. Using probabilistic models, it takes into account the possibility of fire at specific plant locations; propagation, detection and suppression of the fire; effect of fire on safety systems

and equipment; the possibility of damage to them, and in severe fires the structural integrity of the building structures, etc.; and assessment of the impact on plant safety. Many elements of a fire PSA are the same as those used in the deterministic fire hazard analysis. It should be noted, however, that the probabilistic approach includes some new aspects of modeling and applies different acceptance criteria for the evaluation of fire safety.

PSA approach is based on systematic examination of all plant locations. To facilitate this examination, the plant is subdivided into distinct fire locations, which are then scrutinized individually. It is essential to demonstrate that significant fire scenarios have not been overlooked. However, a theoretically complete and exhaustive examination would be both impractical, because of the large number of possible scenarios, and unnecessary, because there are many fires that are unlikely to pose any significant risk. Therefore, an effective screening process is essential to limit the scope of the fire PSA. It is advisable to perform the screening process in stages, starting with relatively simple, conservative models and progressing to more realistic representation of the fire scenarios at subsequent stages. Application of complex models that involve detailed investigation of the evolution of the fire and its impact on safety equipment, as well as the effect of the fire mitigation features, is limited to a relatively small number of fire scenarios. Compared with the deterministic approach, the PSA model introduces some new elements that involve statistical data and as a result, further contributes to uncertainty in the final evaluation of fire safety. This aspect should be taken into account when applying PSA techniques to fires in industrial facilities. In this case, sensitivity and uncertainty analyses are essential for correct interpretation of the results. It should be emphasized that the main advantages of a PSA are that it can identify a number of uncertainties, quantify and describe most of them.

Further details on Fire PSA can be obtained from the document “Treatment of Internal Fires in Probabilistic Safety Assessment for Nuclear Power plants”, Safety Report Series-10 by IAEA.

References:

1. AERB Safety Standard No. AERB/NF/SS/FPS (Rev.1), Fire Protection Systems for Nuclear Facilities
2. IAEA Safety Reports Series No. 8, Preparation of Fire Hazard Analyses for Nuclear Power Plants

5.0 Regulations for Fire Safety

Factories Act, 1948 and rules framed there under specify statutory requirements regarding general fire safety to be implemented by management of factories. Similarly, Part 4 (Fire and Life Safety) of the National Building Code, 2016 deals with safety from fire and specifies requirements necessary to minimize danger to life from fire, smoke, fumes, to be followed during construction of a building. Indian standards give specific requirements for design, installation, testing and surveillance of respective fire systems and equipment. National Fire Protection Association (NFPA) of United States trade association with international members specifies requirements in the form of codes and standards for fire safety.

AERB has authority to administer the provisions of the Factories Act, 1948, the industrial safety for the units of DAE as per Section 23 of the Atomic Energy Act, 1962. The fire safety in DAE units is assessed, reviewed and regulated by Atomic Energy Regulatory Board through regulatory inspection, periodic review, promotional activities etc. The Atomic Energy (Factories) Rules, 1996 gives requirements for fire protection, prevention & fighting in a factory which are related to building design w.r.t fire and life safety, fire safety measures in dangerous machines and dangerous manufacturing processes or operations, fire safety of electrical installations. Detailed provisions can be referred from Atomic Energy (Factories) Rules, 1996.

Construction phase of the plant or building is a dynamic condition where different activities are being carried out by different agencies. Provision to ensure fire prevention should be made and attention should be paid to reduce the amount of combustibles. As welding operations tend to be a frequent cause of fires, adequate precautions shall be taken to prevent fires due to these operations. Appropriate action for inculcating basic fire protection concepts among construction workers should be taken. Further, Fire protection in the nuclear facilities of DAE including DAE units under construction is regulated as per the requirements given in AERB Safety Standard No. AERB/NF/SS/FPS (Rev. 1), Fire Protection Systems for Nuclear Facilities.

References

1. The Atomic Energy (Factories) Rules, 1996
2. AERB Standard for “Fire Protection Systems of Nuclear Facilities” (AERB/NF/SS/FPS – Rev.1)

6.0 Case Studies and lessons learnt

6.1 Lessons learnt from Fire Incidents occurred in DAE units in last 10 years

6.1.1 Fire incident occurred at ECIL, Hyderabad on June 19, 2009

On June 19, 2009 at ECIL, Hyderabad, a fire incident took place near the Thermal Battery Building. The fire originated when the accumulated scrap generated out of the process of manufacturing of pyro-heaters (consisting of pyrophoric zirconium powder, barium chromate and asbestos fibres) was being disposed off by burning in a calcium waste salvage pit outside the building instead of using the designated concrete cubicle tank under the direct supervision of the senior personnel from ECIL. The fire was out of control and also reached the scrap storage room through an open window and caused burn injuries to ten employees including five fatalities. The incident was investigated and reviewed at AERB. The production activities were resumed only after review of the safety report of 'Thermal Battery Division' by AERB, preparation and implementation of checklist and procedure for scrap burning, compliance of all pending directives made by AERB related to training/retraining of the operating personnel for safe handling of pyrophoric material and carrying out fire hazard analysis of the 'Thermal Battery Division', etc.

Lessons learnt:

- Scrap burning yard should be away from the area where industrial processes are being carried out.
- The pyrophoric waste should be burnt at a designated place providing information to fire services.
- Portable fire fighting equipment should be kept near to scrap burning yard.

Reference: AERB Annual Report for 2009-10

6.1.2 Fire incident occurred at Unit-1 of Narora Atomic Power Station (NAPS) on January 9, 2013

At NAPS-1, an incident of fire near bearing-5 area of turbine-generator (TG) occurred on January 9, 2013. A flame was observed near TG bearing -5. Also, the alarms related to low level in intermediate oil tank, low level in seal oil vacuum tank and hydrogen leakage appeared in the main control room. Both TG and reactor were tripped immediately. The primary heat transport system was brought to cold shut down state and core cooling was maintained by shutdown cooling system. Generator hydrogen was purged and TG was brought to stand still condition. Lube oil and seal oil pumps were stopped to isolate oil supply. Fire station personnel reached the affected area and promptly extinguished fire within 8 minutes. The event resulted in damage to TG bearings and instruments & cables used for monitoring turbine parameters. The fire was caused by escape of hydrogen and oil mixture from the turbine side generator seal housing and the ignition provided by the TG shaft earthing brush located nearby. The escape of hydrogen from generator seal oil housing could be due to stuck opening of Intermediate Oil Tank (IOT) float valve or inadvertent operation of bypass valve in the drain line of IOT.

In absence of any recording of the IOT and Vacuum tank level, no trend or performance assessment by the operator is possible in case of any mal function of float valves. It was decided to hookup vacuum tank level transmitter and one of the two level transmitters for IOT with an alarm for the warning to the operator.

Lesson learnt:

- Hydrogen detector should be provided near to turbine side generator seal housing for early detection and taking mitigation measures.

Reference: AERB Annual Report for 2012-13

6.2 Lessons learnt from Fire Incidents occurred in other industries**6.2.1 Fire Incident occurred at Indian Oil Corporation's Petroleum Oil Lubricants Terminal at Sanganer in Jaipur on October 29, 2009**

A devastating fire occurred in Petroleum Oil Lubricants Terminal during transfer of petroleum product by crew of four persons i.e. shift officer and 3 operators. A huge leakage of the product took place from the blind valve on the delivery line of the tank. The vapors of the leaking product incapacitated the two operators and shift officer and the third operator was not available at site. With none of the operating crew being available, the leakage was

unrestricted, making the entry into area not only difficult but also dangerous. After some time, there was a massive explosion followed by a huge fireball covering the entire installation.

The source of ignition could have been from one of the non-flame proof electrical equipment out of the flammable zone area, or from a vehicle being started in the installation.

The main causes of fire were:

- a. Absence of site specific written operating procedures giving information on sequence of safe valve operation
- b. Shortcomings in design (absence of leakage stopping devices from a remote location).
- c. Insufficient understanding of hazards and risks and consequences.
- d. Non-availability of a Self-Contained Breathing Apparatus (SCBA) and Fire Suit leaving the entire response team as mere helpless spectators in mitigating the incident.

Lessons learnt:

- Redundancy in safety systems should be incorporated in facilities and installations with inherently high hazards.
- Management should ensure that reliable systems are in place to give timely feedback on the current practices and state of readiness in different facilities.
- Management must also ensure that identified actions are being carried out.
- A high priority on safety from the senior and top management will convey right signals down the line to ensure safety in production.
- High degree of operational competence should be maintained at all times by building on the combined knowledge and experience of all the professional groups.

Reference: Executive Summary of IOC Fire Accident Investigation Report downloaded and referred from website: <https://www.oisd.gov.in>

6.2.2 Fire Incident occurred at AMRI Hospital at Kolkata on December 9, 2011

On December 9, 2011 at 0230 hrs, a fire incident took place at AMRI Hospital, Kolkata due to short circuit in the basement. The fire started in the basement where the pharmacy and the godown were located. The area contains highly combustible material such as PVC pipes, mattresses, oxygen and LPG cylinders, engine oil. When the fire was sparked off, dense smoke started rising out of the basement and entered the upper floors incapacitating many people who are sleeping. With no outlet / openable windows, the smoke started circulating in the building, choking the patients and the staff. The fire affected at least 93 people and all were choked to death with no burn injuries.

Lessons learnt:

- The cause of fire was due to electric short circuit in the basement. *All the electrical equipment should be properly maintained by periodic inspection and preventive maintenance.*

- The hospital staff started fire fighting operations on their own without initiating a fire alarm or informing the fire brigade. This resulted in loss of initial crucial time. *In case of fire, the fire services should be immediately informed.*
- Internal fire hydrants /sprinkler system were either non-functional OR the staff were not trained to operate them in an emergency situation. This resulted in the fire spreading rapidly and out of control . The fire alarm system for the building was found switched off to avoid false alarms. This resulted in no fire alarm alert and centralized AC system too did not trip automatically. *Firefighting / life safety systems should be commissioned and maintained in a Ready to Operate condition all the time.*
- Emergency lighting too did not work / nor was adequately available resulting in total darkness inside the building hampering rescue / firefighting. *Life safety systems, lifts, emergency lighting, peripheral lights etc shall be provided with uninterrupted power.*
- The Fire Brigade vehicles could not reach closer to the building since the approach route was halved due to DG set installation and Gas Bank and emergency vehicles could not turn through the narrow passage. *Approach and peripheral roads should be designed and maintained for ease access to fire brigade vehicles.*
- External glass façade made of double glass panes were very difficult to break and the building had no operable windows to dissipate smoke which resulted in many deaths due to suffocation / asphyxia. *Emergency windows/ doors should be provided that can be opened easily during emergencies. These doors/ windows should be marked with signage and periodically checked for operability.*

Reference: Learning's from AMRI Hospital Fire, downloaded and referred from website: <http://nafoindia.org/>

6.2.3 Fire Incident occurred at Arkema Crosby on August 31, 2017 following Hurricane Harvey Flooding

On August 24, 2017, Hurricane Harvey made landfall in southeast Texas and produced unprecedented amounts of rainfall over southeast Texas, causing significant flooding. The Arkema Crosby facility is located within the 100-year and 500-year flood plain. Extensive flooding caused by heavy rainfall from Hurricane Harvey exceeded the equipment design elevations and caused the plant to lose power, backup power, and critical organic peroxide refrigeration systems. Consequently, Arkema used its standby refrigerated trailers to keep the organic peroxide products cool. This flooding also eventually forced all Arkema's employees to evacuate from the facility. On August 31, 2017, organic peroxide products stored inside a refrigerated trailer decomposed, causing the peroxides and the trailer to burn. Twenty-one people sought medical attention from exposure to fumes generated by the decomposing products when the vapor travelled across a public highway adjacent to the plant. Emergency response officials initially decided to keep this highway open, despite the fact that it ran through the established evacuation zone around the Arkema facility, because this road served as an important route for hurricane recovery efforts. Over the next several days, a second fire and a controlled burn consumed eight more trailers holding Arkema's remaining organic peroxide products that required low temperature storage. Over the course

of the three fires, about 158 tonnes of organic peroxide was released and burnt. As a result, more than 200 residents living within 2.4 km of the facility who had evacuated the area could not return home for a week.

Lessons learnt:

- Arkema had multiple safety systems in place to ensure that organic peroxide products were kept cold and would not reach their Self-Accelerating Decomposition Temperatures (SADT). Arkema's process hazard analysis (PHA) team members identified the redundant refrigeration systems in the Low Temperature Warehouses; emergency generators to provide power in case a Low Temperature Warehouse lost power; liquid nitrogen for alternative cooling; and refrigerated trailers to store organic peroxide temporarily as layers of protection. All of these layers of protection failed during Hurricane Harvey because of flooding which was a common mode of failure. The Arkema team that performed the Low Temperature Warehouse PHA for the Crosby facility did not document any flooding risk. *Facilities should ensure that critical safeguards and equipment are not susceptible to common mode failures. For flooding scenarios, independent layers of protection should be available if floodwater heights reach the facility.*
- Arkema Crosby facility was constructed before any flood maps or studies of the area were developed. Initial flood map for the area encompassing the Arkema Crosby facility showed minimal flood risk for the facility. In 2007, flood map revision established that the entire Arkema Crosby facility sits within a floodplain. Some portions of the facility are in the 100-year floodplain, and the remaining areas of the site are in the 500-year floodplain. Although Federal process safety regulations require companies to compile relevant process safety information, the regulations do not specifically identify flood insurance maps and related studies as required process safety information. The Chemical Safety Board investigation revealed that other companies also might be unaware of the potential for flood risks to create process safety hazards at their facilities if flood-related information is not typically compiled or assessed in required safety analyses. *This requires periodic site re-evaluation for facilities, which should be a mandatory requirement for re-licensing.*
- Highway, which bisected the evacuation zone, remained open to traffic even after emergency response officials established the evacuation zone. This decision resulted in at least 21 people were exposed to decomposition products and smoke from the burning refrigerated trailer and organic peroxides. *Siting of facility should ensure that there are no nearby transport highways nearby.*

Reference: Investigation Report of Organic Peroxide Decomposition, Release, and Fire at Arkema Crosby Following Hurricane Harvey Flooding by U.S. Chemical Safety and Hazard Investigation Board, downloaded and referred from website: <http://www.csb.gov/>

6.3 Fire Incidents in day to day life

6.3.1 Accumulation of combustible waste

A shopkeeper regularly threw packing waste by the back door of his shop as he quickly stocked the shelves after a delivery. His workers sometimes opened the back door to have a cigarette break outside.

The shopkeeper had left the pile of rubbish for several days and a discarded cigarette has caused it to catch fire. By the time the fire was spotted and put out, it had caused substantial damage to stock. This fire could have been easily prevented if there is no accumulation of combustible waste.

Lesson learnt:

- Combustible waste should be disposed off regularly.

Reference: Website of Health Safety & Executive <http://www.hse.gov.uk/toolbox/fire.htm>

6.3.2 Use of wrong fire extinguisher

Following incidents highlight the significance of selection of appropriate fire extinguisher suitable for particular type of fire.

- a) In a plant, metallic waste powder caught fire. The near-by workers thought that fire can be extinguished with water and poured water onto the fire. The result is magnification of fire due to generation of hydrogen, which is fuel to fire.
- b) In canteen, the hot oil in frying pan caught fire. The nearby personnel used water instead of foam extinguisher resulting in wasted efforts of extinguishing fire. The water is denser than oil and resulted in oil layer floating over the water, thereby maintaining the inventory of oil for fire.

Lesson learnt:

- During fire fighting, usage of appropriate fire extinguisher is necessary for personnel safety.

7.0 Conclusion

The monograph on fire safety is an attempt to highlight the importance of fire safety. It is a subject concerning to all human beings due to its consequences. Important aspects of fire safety are enumerated below:

- a) Cognizance of fire risk - Risk of fire should never be ignored or overlooked or underestimated in industries, in residential buildings or in public places. As most fires start directly or indirectly by human errors, it calls for utmost caution on the part of all individuals.
- b) Prevention of Fire - Efforts should be put to prevent initiation of fire through preventive measures. The preventive measures can be best engineering practices, administrative procedures, regulatory requirements, etc.

- c) Prompt detection - Early detection helps a lot in mitigating losses/damages to personnel and property. Reliable devices, detectors and alarm systems should be provided. These should be regularly tested and maintained.
- d) Human actions/ rescue - Approved and time-tested procedures should be available to guide the human actions. The escape routes/emergency exits should be available in poised state and all the occupants should be made aware of them through regular exercises/drills.
- e) Fire safety attitude - Personnel should be educated/trained on safe habits. The causes of fire like presence of combustibles, ignition sources and gases /vapors evolved during combustion and their hazards involved etc. as well as type of fire extinguishers to be used should be demonstrated.

Acknowledgement

The Members of Task Force for revision of monograph on Fire Safety acknowledges Shri K. Ramprasad, Shri Ashis Kumar Panda and Shri Diptendu Das, Authors of previous edition of the Monograph, which provided basis for the present revised document.

Taskforce members also acknowledges Shri G. Nageswara Rao, Chairman, AERB, Shri Dinesh Kumar Shukla, Executive Director, AERB, Shri C. S. Varghese, Director, Nuclear Facilities Regulations Group, AERB and Shri A. P. Garg, Head, Operating Plants Safety Division for giving the opportunity of revision of this Monograph.

Inputs provided by Shri L. B. Mahale, Head, IGCAR-IFS, OPSD, AERB and Shri Lakshman N. V., EIC, OPSD, AERB are also sincerely acknowledged.

The members of task force also acknowledges Smt. Pinki Choudhary, Shri Subhash Kodolkar, Smt. Pammy Goswamy and Shri Avimanyu Banerjee of AERB for giving their valuable comments and suggestions.

Members of Taskforce for revision of monograph on Fire Safety

Shri Phanikarthik V., AERB

Shri Vora Allarakha, AERB

Ms. Paridhi Aggarwal, AERB

Shri Vishvajit Bhatkhande, AERB